

KASPIAN 2

S128-REG2W2S

A	B	C	D	
1	S128-0002	822	176	3/4
2	S128-023	1468	408	4/4
3	S128-024	1468	408	4/4
4	S128-105	1964	396	1/4
5	S128-106	1964	396	1/4
6	S128-209	900	399	2/4
7	S128-316	862	370	2/4
8	S128-326	863	370	2/4
9	S128-401	863	60	2/4
10	S128-902	1935	893	1/4
11	S128-9926	780	348	1/4
12	BP-503	350	120	2/4
13	BP-504	350	120	2/4
14	ZP-5503	770	120	2/4

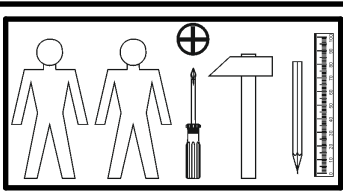
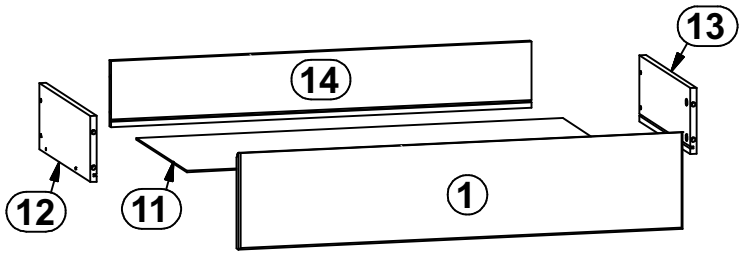
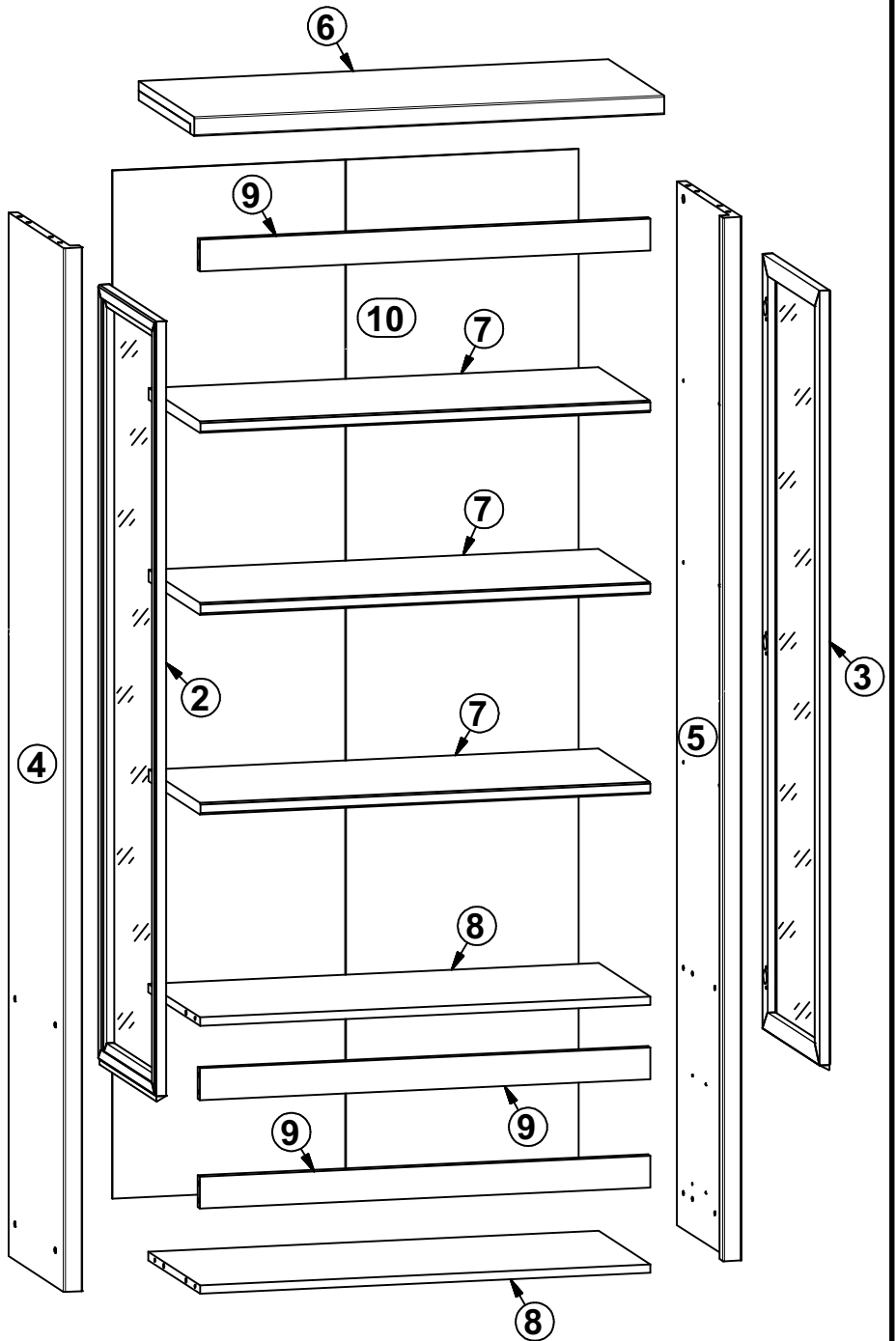
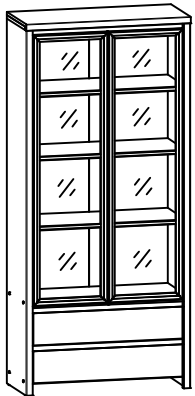

6x a1	6x b12	6x b8	12x φ5x17 mm d1	8x φ7x50 mm e1	12x φ6x30 mm e16	8x φ5x9 mm e19	12x φ6,3x30 mm e23	24x φ8x30 mm f1
8x φ6,5x40 mm f25	4x k1	65x l1	4x φ3,5x16 mm p25	12x φ1,5x12mm #16 r1	12x r42	8x s1	2x ø16 s2	2x 333 mm t19
12x h=18 mm w36	2x 350 mm w45\CL	2x 350 mm w45\CR	2x 350 mm w45\DL	2x 350 mm w45\DR	1x z1	1x n26\1	1x φ3,5x16 mm p38	

1

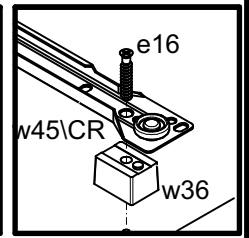
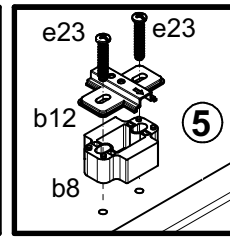
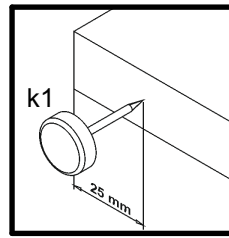
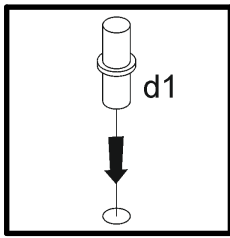
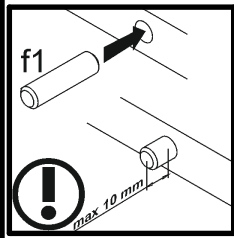
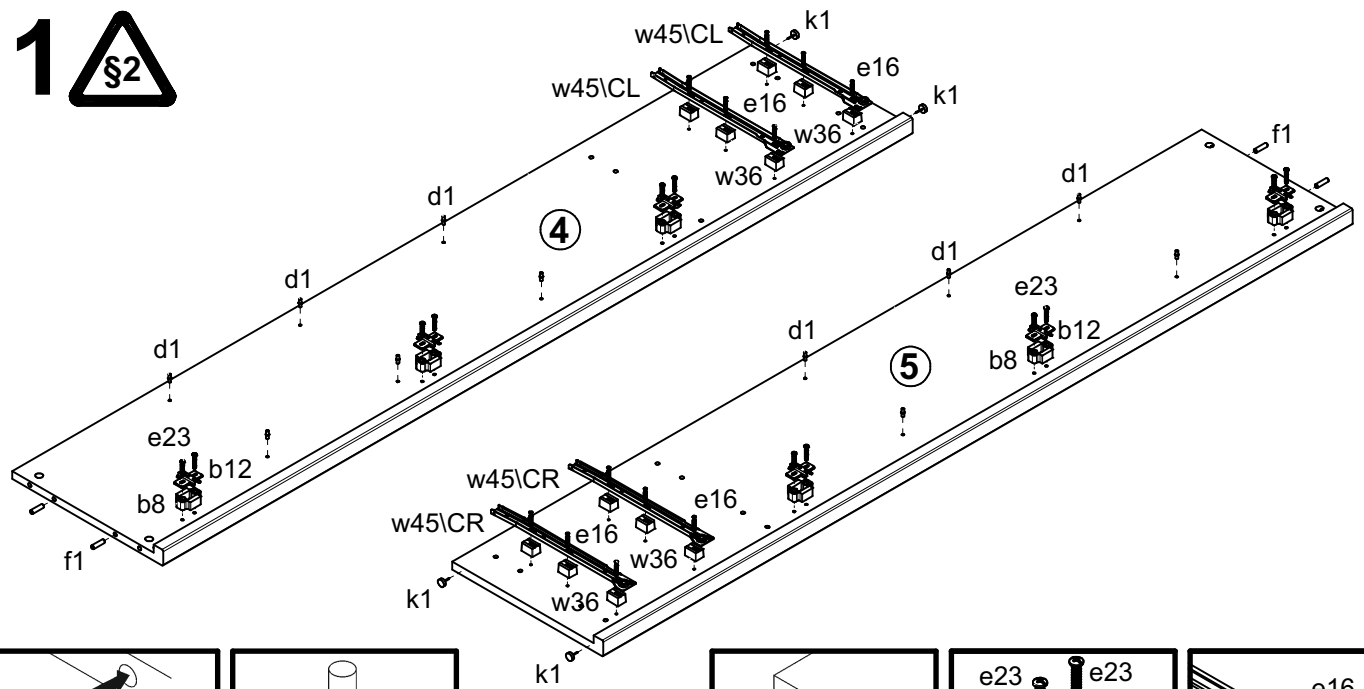

2

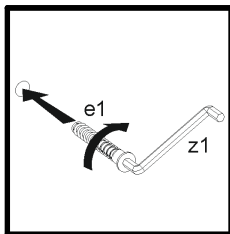
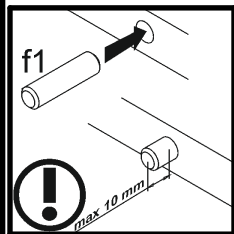
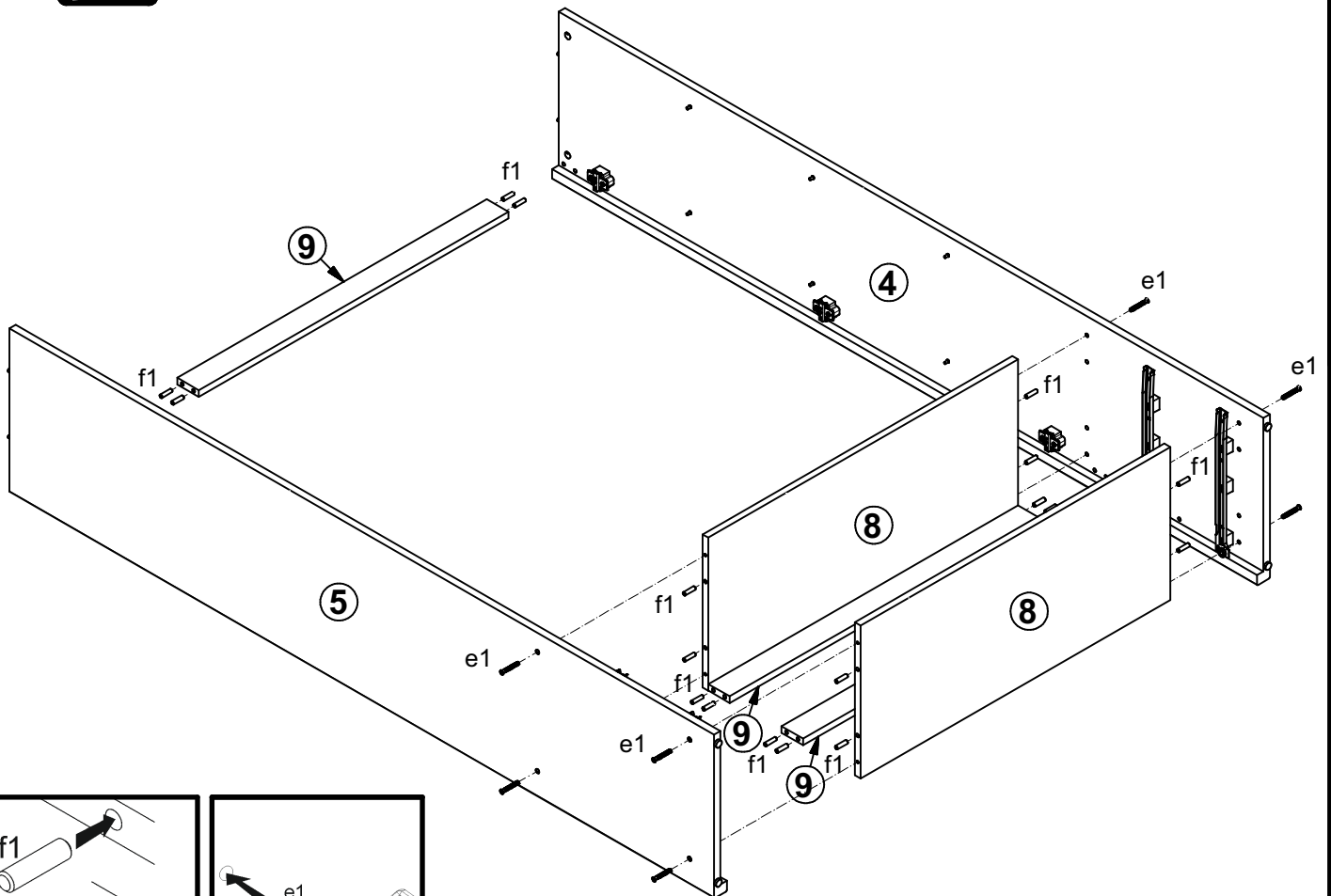

3

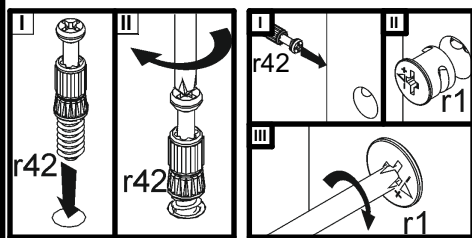
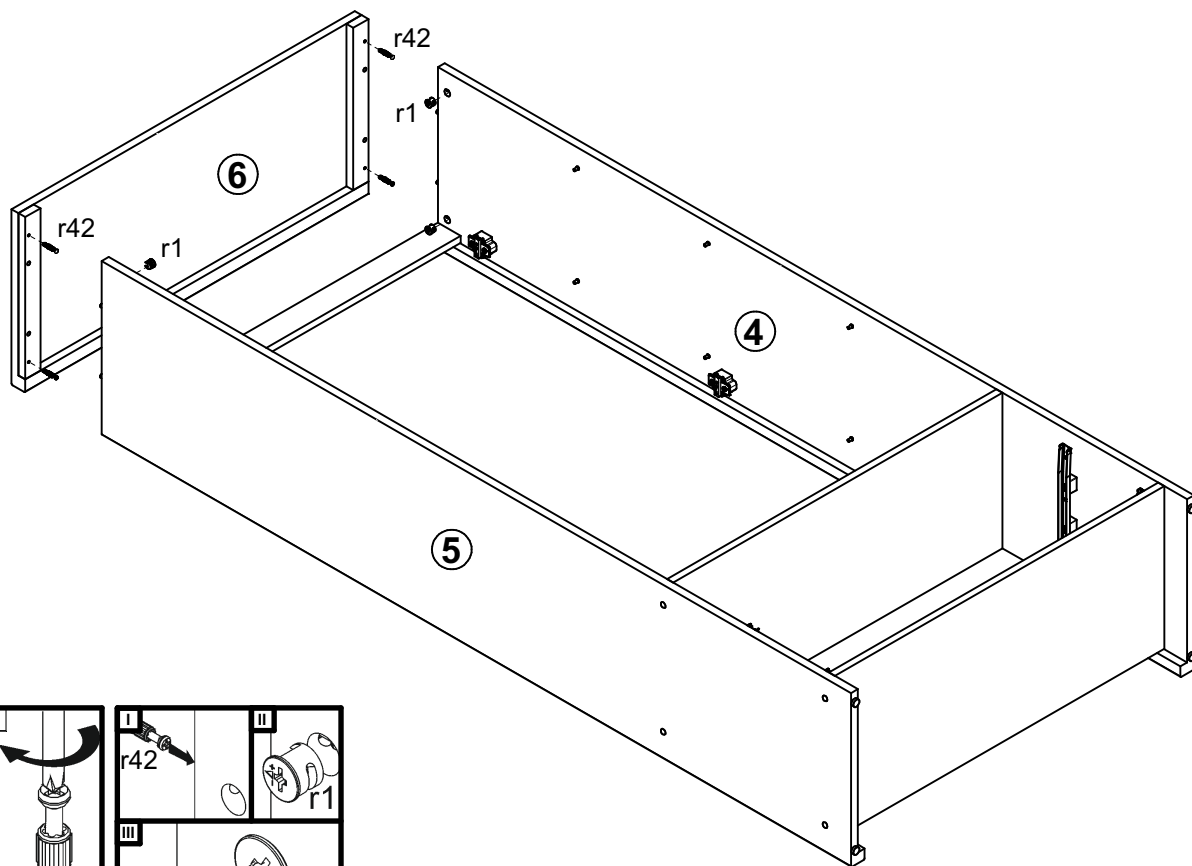

4

